

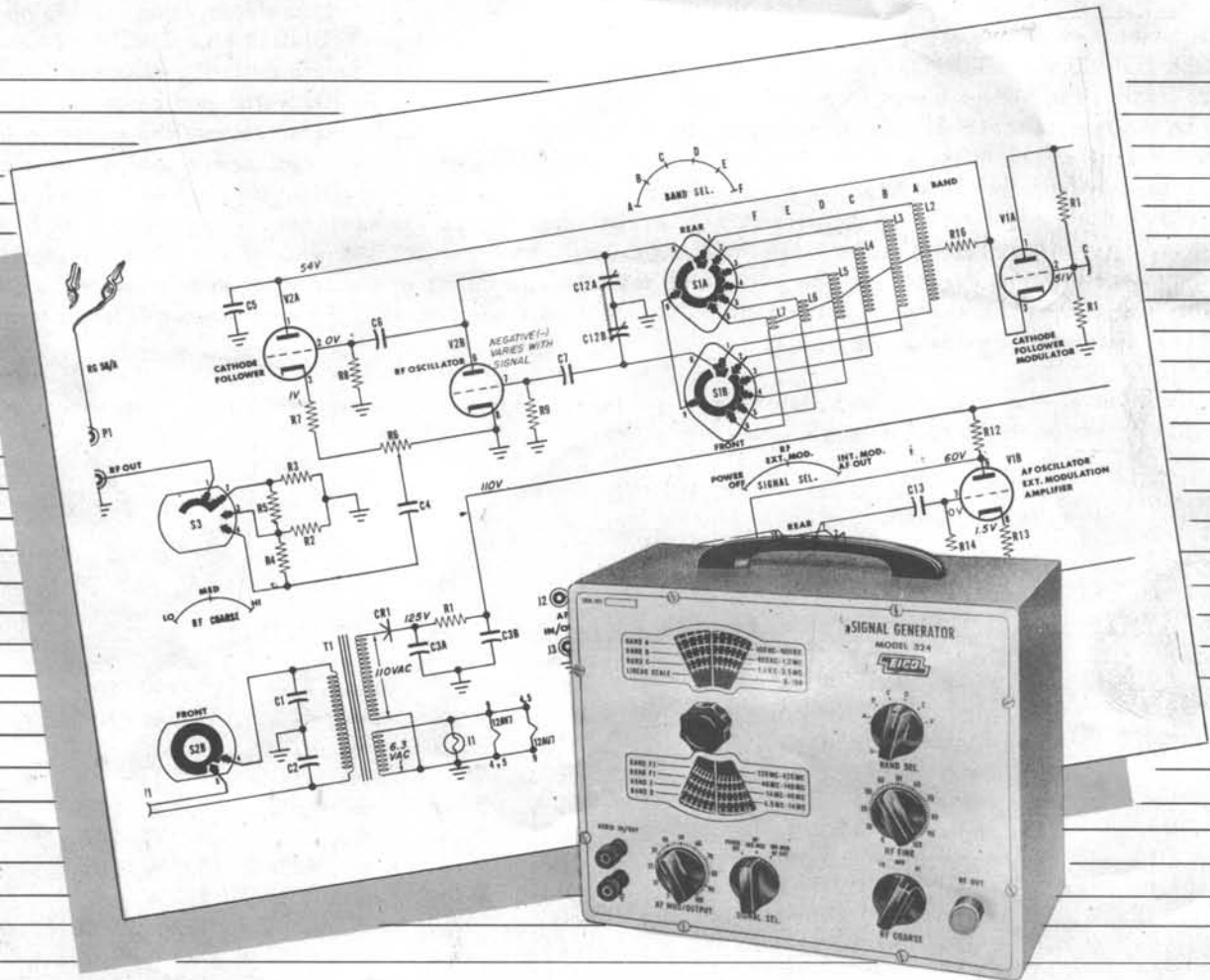

# CONSTRUCTION MANUAL

## MODEL 324 SIGNAL GENERATOR



ELECTRONIC INSTRUMENT CO., Inc.

Care taken in the construction of this instrument will reward the constructor with many years of satisfactory service and greater confidence in his instrument. We urge you to not rush the construction, but to take all the time necessary for proper assembly and wiring.

Furthermore, we urge strongly that you follow the wire and parts layout shown in the pictorial diagrams as closely as possible. This is essential, because the position of wires and parts is quite critical in this instrument; changes may seriously affect the characteristics of the circuit.

**UNPACKING THE KIT:** Unpack the kit carefully and check each part against the parts list including those parts that are mounted to the chassis. If you have trouble identifying any parts, refer to the pictorial diagrams or the color code chart.

You may find that the value of a component will vary within the allowable circuit tolerance. As an example, a 470K ohm resistor may have substituted for it a 510K ohm resistor if the circuit is such as to allow this substitution. In general, resistors and controls have a tolerance of  $\pm 20\%$  unless otherwise specified. Therefore a 100K resistor may measure anywhere between 80K and 120K ohms. Tolerances on capacitors are even greater, unless specified. Limits of +100% and -50% are usual for electrolytic capacitors.

**CONSTRUCTION HINTS:** USE THE BEST GRADE OF ROSIN CORE SOLDER ONLY, preferably one containing the new activated fluxes such as Kester "Resin-Five", Ersin "Multicore" or similar types. UNDER NO CIRCUMSTANCES USE ACID CORE SOLDER OR ACID FLUX since acid flux can cause serious corrosion. Before soldering make certain of a good mechanical connection. Use a clean, freshly tinned soldering iron, no smaller than 100 watts, and place the solder on the joint (not on the iron) so that the solder is melted by the heat from the joint itself. Do not remove the soldering iron until the solder flows and check to see that the resulting joint is smooth and shiny when the solder has cooled. There are two extremes to be avoided; too little heat and too much heat. If too little heat is applied, the joint will appear pitted and grey, indicating a rosin joint which is unsatisfactory. On the other hand, if too much heat is applied to a joint, the parts connected to it may either change value, lose their protective coating, or break down. If you are soldering close to a part, hold the lead between the part and the joint being soldered with the tip of a pair of longnose pliers. The pliers will conduct the heat away and prevent the component from being unduly overheated. If for any reason it is necessary to resolder a joint, be sure to use new solder.

It should also be noted that the leads on transformers, capacitors, and resistors are very often longer than necessary. These leads should be trimmed to the proper length when wiring.

## PARTS LIST

| STOCK# | SYM.    | DESCRIPTION                  | AM'T. | STOCK# | SYM. | DESCRIPTION                           | AM'T. |
|--------|---------|------------------------------|-------|--------|------|---------------------------------------|-------|
| 20000  | C1,2,13 | cap., paper, .01 mf-400V     | 3     | 10041  | R1   | res., 2.2K $\Omega$ , 1/2 W, 20%      | 1     |
| 23009  | C3      | cap., elec., 2 X 20 mf-150V  | 1     | 10002  | R2,3 | res., 47 $\Omega$ , 1/2 W, 20%        | 2     |
| 22500  | C4,5    | cap., disc., 1000 mfmf       | 2     | 10005  | R4,5 | res., 470 $\Omega$ , 1/2 W, 20%       | 2     |
| 22008  | C6      | cap., cer., 5 mfmf           | 1     | 16013  | R6   | pot., 200 $\Omega$ , (RF FINE)        | 1     |
| 22007  | C7      | cap., cer., 47 mfmf          | 1     | 10040  | R7   | res., 68 $\Omega$ , 1/2 W, 20%        | 1     |
| 20006  | C8,9    | cap., paper, .1 mf-400V      | 2     | 10018  | R8,9 | res., 22K $\Omega$ , 1/2 W, 20%       | 2     |
| 20001  | C10     | cap., paper, .05 mf-400V     | 1     | 10028  | R10  | res., 470K $\Omega$ , 1/2 W, 20%      | 1     |
| 20008  | C11     | cap., paper, .02 mf-400V     | 1     | 10419  | R11  | res., 270K $\Omega$ , 1/2 W, 10%      | 1     |
| 29004  | C12     | cap., tuning                 | 1     | 10424  | R12  | res., 22K $\Omega$ , 1/2 W, 10%       | 1     |
| 93003  | CR1     | rect., 50 ma                 | 1     | 10432  | R13  | res., 1K $\Omega$ , 1/2 W, 10%        | 1     |
| 92000  | I1      | bulb, #47                    | 1     | 10410  | R14  | res., 100K $\Omega$ , 1/2 W, 10%      | 1     |
| 50002  | J1      | amphenol, male               | 1     | 16002  | R15  | pot., 250K $\Omega$ (AF MOD/OUTPUT)   | 1     |
| 52001  | J2,3    | binding post, 5 way          | 2     | 10012  | R16  | res., 4.7K $\Omega$ , 1/2 W, 20%      | 1     |
| 34501  | L1      | choke a.f. resonant          | 1     | 60032  | S1   | switch, BAND SEL., 6 pos.             | 1     |
| 36003  | L2      | coil "A"                     | 1     | 60033  | S2   | switch, SIGNAL SEL., 3 pos.           | 1     |
| 36004  | L3      | coil "B"                     | 1     | 60034  | S3   | switch, RF COARSE, 3 pos.             | 1     |
| 36005  | L4      | coil "C"                     | 1     | 30013  | T1   | transformer, power                    | 1     |
| 36006  | L5      | coil "D"                     | 1     | 54011  | TB1  | term. post, 1 post dual lug, vertical | 1     |
| 36007  | L6      | coil "E"                     | 1     | 54003  | TB2  | term. post, 2 post                    | 1     |
| 36008  | L7      | coil "F" (straight bare wire | 1     | 54002  | TB3  | term. post, 1 post right w/gnd.       | 1     |
| 51000  | P1      | amphenol, female             | 1     | 90013  | V1   | 12AU7 tube                            | 1     |

| <u>STOCK#</u> | <u>SYM.</u> | <u>DESCRIPTION</u>                 | <u>AM'T.</u> | <u>STOCK#</u> | <u>SYM.</u> | <u>DESCRIPTION</u>           | <u>AM'T.</u> |
|---------------|-------------|------------------------------------|--------------|---------------|-------------|------------------------------|--------------|
| 90022         | V2          | 12AV7 tube                         | 1            | 58300         |             | spaghetti                    | pc.          |
| 97707         | X11         | pilot lite assembly                | 1            | 41006         |             | screw, 10-24 X 3/8           | 2            |
| 97025         | XV1,2       | tube socket, 9 pin miniature       | 2            | 41035         |             | screw, self-tapping, #6 P.K. | 9            |
| 57000         |             | line cord                          | 1            | 40001         |             | nut, hex, 3/8"               | 11           |
| 80039         |             | panel                              | 1            | 42000         |             | washer, lock, 3/8"           | 5            |
| 89543         |             | dial plate w/bushing               | 1            | 42001         |             | washer, flat, 3/8"           | 6            |
| 81059         |             | chassis                            | 1            | 43001         |             | ground lug, 3/8"             | 3            |
| 81060         |             | subchassis                         | 1            | 42018         |             | washer, fibre shoulder, #8   | 2            |
| 88021         |             | cabinet                            | 1            | 42017         |             | washer, fibre flat, #8       | 1            |
| 87000         |             | handle                             | 1            | 42008         |             | washer, lock, #8             | 2            |
| 46005         |             | rubber foot                        | 4            | 43004         |             | lug, #8                      | 1            |
| 46000         |             | grommet, 3/8"                      | 1            | 40008         |             | nut, hex, #8                 | 3            |
| 89534         |             | plastic window                     | 1            | 41016         |             | screw, 4-40 X 1/4            | 4            |
| 53006         |             | knob, round bar                    | 5            | 40007         |             | nut, hex, 4-40               | 4            |
| 53003         |             | knob, small tuning (scalloped rim) | 1            | 41010         |             | screw, 6-32 X 1/8            | 3            |
| 51502         |             | crocodile clip                     | 2            | 41000         |             | screw, 6-32 X 1/4            | 6            |
| 58000         |             | hook-up wire                       | pc.          | 40000         |             | nut, hex, #6                 | 7            |
| 58405         |             | cable, 50Ω                         | 4 ft.        | 43000         |             | ground lug, #6               | 4            |
| 58500         |             | bare wire, #14                     | pc.          | 42002         |             | washer, lock, #6             | 6            |
| 58501         |             | bare wire, #22                     | pc.          | 85001         |             | bushing, 1/4 I.D.            | 1            |
| 58301         |             | heavy tubing                       | pc.          | 66008         |             | instruction book             | 1            |
|               |             |                                    |              | 66258         |             | construction book            | 1            |

NOTE: When ordering replacement parts, please include all of the following information: 1) stock number and description given in parts list; 2) quantity; 3) model number of instrument; 4) serial number of instrument (on panel). This information will expedite the processing of your order and insure your receiving the correct replacement parts.

## CONSTRUCTION PROCEDURE

**CONSTRUCTION PROCEDURE:** The step-by-step mounting and wiring procedure given below allows you to complete the mounting and wiring in a systematic manner. When you have completed a mounting or wiring instruction, check it off in the space provided. The method and location of mounting or the proper way to run a particular lead is shown in the accompanying drawings. To keep the drawings uncrowded, unnecessary repetition of mounting or wiring details may be omitted.

**NOTE:** In some cases, more than one connection is made to the same terminal. This condition is designated in the wiring instructions by the abbreviation (C), meaning that the connection should not be soldered until other leads have been connected. Where only one lead is connected to a terminal, or where the last of several leads is connected, the abbreviation (S) will be given. (S) means that the joint should be soldered.

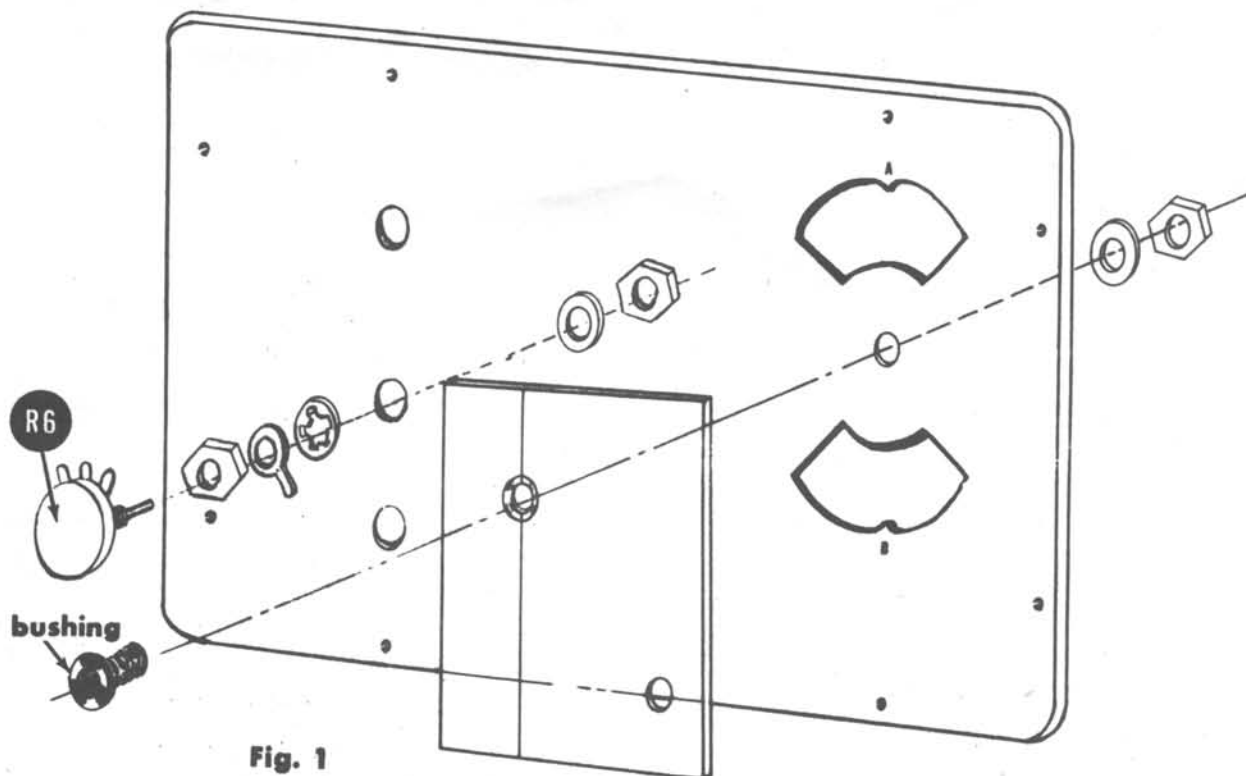

Fig. 1

- ( ) Fig. 1. Mount the plexiglass window to the panel with the bushing, 1-3/8 flat washer, and 1-3/8 hex nut. Note that the hole in the window used for mounting is counterbored to accept the bushing and that the panel lamp hole in the window is at the lower right in the rear view. Note also that there is a scribed hairline on the back surface of the window which passes through the center of the mounting hole. Before tightening the nut, line up the window so that both indicating points A & B on the panel lie directly over the hairline.
- ( ) Fig. 1. Mount the RF FINE potentiometer R6 (200Ω) to the panel, using 2-3/8 hex nuts, 1-3/8 ground lug, 1-3/8 lock washer, and 1-3/8 panel washer.
- ( ) Fig. 2. Mount the power transformer T1 to the chassis. Along with it mount the 2X20 electrolytic capacitor C3 and the 1 post right w/gnd terminal strip TB3. Use 2 #6-32 X 1/4 screws, 2 #6 lock washers, and 2 #6 hex nuts.
- ( ) Fig. 2. Mount the selenium rectifier CR1, positioning it with the positive terminal as shown. Use 1 #6 lock washer, and 1 #6 hex nut.
- ( ) Fig. 2. Mount the 9-pin miniature socket XV1, positioning it with the blank (no pin) sector as shown. Along with it mount terminal strip TB1 (double lug - not grounded). Use 2 #4-40 X 1/4 screws, 2 #4-40 hex nuts, 1 lock washer, and 1 ground lug.
- ( ) Fig. 2. Mount a.f. resonating choke L1 to the chassis, first passing the 2 black leads through hole "X". Along with it mount the 2 post terminal strip TB2. Use 2 #6-32 X 1/4 screws, 2 #6-32 hex nuts, 1 #6 lock washer, and 1 ground lug.

The following five steps accomplish the mounting of the chassis to the panel.

- ( ) Fig. 2. Mount the male amphenol connector J1 (RF OUT) to panel and chassis using the hardware shown.
- ( ) Fig. 2. Mount the 250K $\Omega$  AF/MOD OUT potentiometer R15 to panel and chassis, using 2 - 3/8 hex nuts, 1 - 3/8 lock washer, 1 ground lug, and 1 panel washer. The inside hex nut should be used as a back-up nut so that the potentiometer bushing does not extend past the outside nut.
- ( ) Fig. 2. Mount the RF COARSE switch S3 to panel and chassis using the same hardware as above including the ground lug. Note the positioning of S3 in the drawing and observe it in the mounting. Do not tighten outside hex nut finally as yet.
- ( ) Fig. 2. Mount the SIGNAL SEL. switch S2 to panel and chassis using the same hardware as above but no ground lug. Note the position of S2 in the drawing and observe it in the mounting. Here also do not tighten the outside hex nut

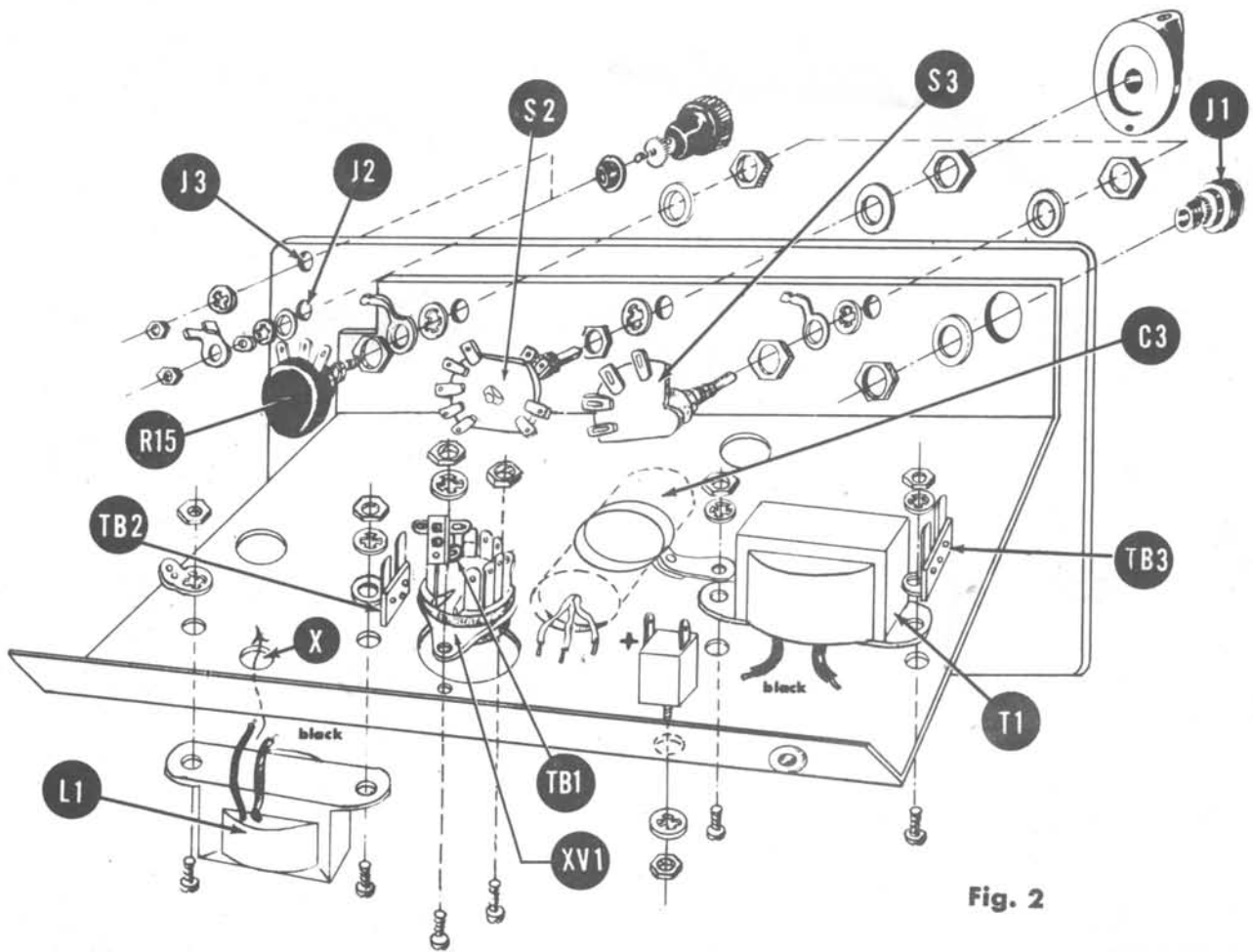

Fig. 2

- ( ) Fig. 2. Place the panel and chassis on its side. Use a pair of pliers to turn the shafts of both the SIGNAL SEL. switch S2 and the RF COARSE switch S3 to the furthest counter-clockwise position. Next orient switch S2 so that the flat on the shaft faces away from the POWER OFF position and tighten the panel nut finally. Now orient switch S3 so that the flat on the shaft faces away from the LO position and then tighten the S3 panel nut finally. The assembly of panel to chassis is now completed.
- ( ) Fig. 2. Mount the AF IN/OUT binding posts J2 and J3 on the panel. Note that J2 is insulated from the panel and that J3 is not insulated. Use 1 #8 fibre shoulder washer (for insulation), 1 #8 fibre flat washer, 1 #8 lock washer, 1 #8 lug, and 2 #8 hex nuts to mount J2 and the same hardware less the fibre flat washer and the lug to mount J3.
- ( ) Fig. 2. Install the 3/8" rubber grommet in the hole provided in the rear chassis apron. Squeeze the grommet into oval shape to start it in the hole and then work it in completely with a small screwdriver.



- ( ) Fig. 3. Mount the tuning capacitor C12 to the sub-assembly bracket using 3 #6-32 X 1/8 screws. To protect C12 during this operation, turn the shaft fully counter-clockwise so that the rotor and stator are fully meshed.
- ( ) Fig. 3. Mount the 9-pin min. socket XV2 on the sub-assembly bracket using 2 #4-40 X 1/4 screws, 2 #4-40 hex nuts, and 2 ground lugs. Orient the socket with the blank (no pin) sector as shown in the drawing.
- ( ) Fig. 4. Connect a 22K $\Omega$  resistor, R8 from XV2-2 (C) to XV2-8 (C).
- ( ) Fig. 4. Connect a short length of bare wire from XV2-8 (S) to ground lug A (C).
- ( ) Fig. 4. Connect a 1000 mmf capacitor C5 from XV2-1 (C) to ground lug A (S).
- ( ) Fig. 4. Connect the 5 mmf capacitor C6 from XV2-2 (S) to XV2-6 (C).
- ( ) Fig. 4. Connect a short length of bare wire from XV2-6 (S) to C12A (C).
- ( ) Fig. 4. Connect a short length of bare wire from XV2-4 (S), thru XV2-5 (S) to ground lug B (C).
- ( ) Fig. 4. Connect the other 22K resistor R9 from ground lug B (S) to XV2-7 (C).
- ( ) Fig. 4. Connect the 47 mmf capacitor C7 from XV2-7 (S) to C12B (C).

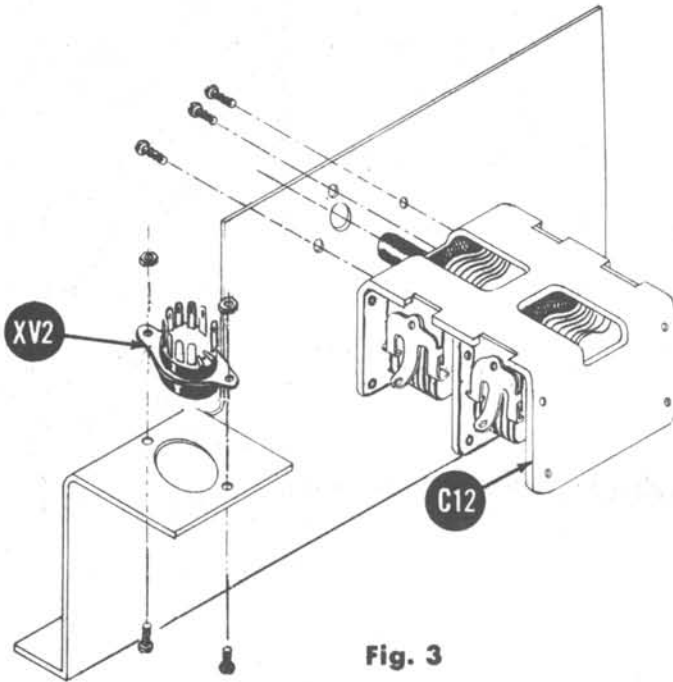

Fig. 3

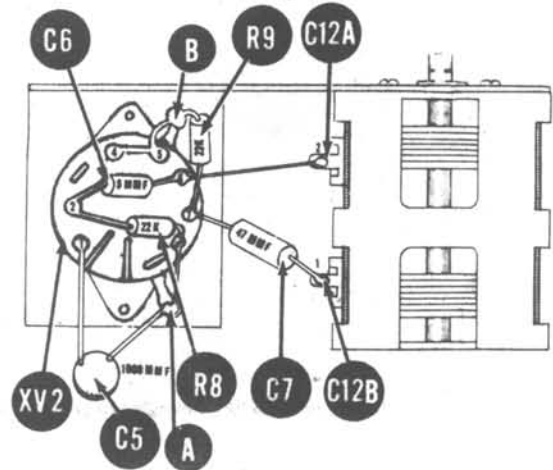

Fig. 4

#### PREWIRING OF BAND SELECTOR SWITCH S1

Prewire band switch S1 as shown in Fig. 5 (rear view). As S1 is the only two-wafer switch in the kit, it cannot be mistaken. The wafer nearest the knob end is designated as section A and the other wafer as section B. Coils L2 to L6 and the length of bus bar which at the high frequencies of band F acts as inductance L7 are wired between corresponding terminals on the two wafers as shown.

In order to do this job properly, examine any one of the coils and note that there are three terminals, numbered 1, 2, and 3 on the insert drawing of Fig. 5. Terminal 1 (nearest the tuning slug) is one end of the coil, terminal 3 is the other end of the coil, and terminal 2 is the tap on the coil. The wafers of S1 are spaced the same distance as coil terminals 1 and 3 so that each coil can be conveniently connected between corresponding terminals on each wafer. Please observe the following precautions when wiring in the coils, as otherwise one or more coils may be irreparably damaged: 1) Take care that your soldering iron does not accidentally come in contact with any coil; 2) Do not overheat any coil terminal (solder quickly with a hot iron using a minimum amount of solder); 3) Do not attempt to move any coil terminal as it may result in breaking the connection to the coil.

Each of the wound coils can be readily identified by the stock number which is referred to in the step-by-step wiring instructions that follow.

- ( ) Fig. 5. Place coil L2 (stock# 36003) on switch S1 so that L2#1 rests on S1B#1 and L2#3 rests on S1A#1. Solder L2#1 to S1B#1 and L2#3 to S1A#1.
- ( ) Fig. 5. Similarly position coil L3 (stock# 36004) on the S1B#2 and S1A#2 terminals of S1. Solder L3#1 to S1B#2 and L3#3 to S1A#2.
- ( ) Fig. 5. Similarly position coil L4 (stock# 36005) on the S1B#3 and S1A#3 terminals of S1. Solder L4#1 to S1B#3 and L4#3 to S1A#3.
- ( ) Fig. 5. Similarly position coil L5 (stock# 36006) on the S1B#4 and S1A#4 terminals of S1. Solder L5#1 to S1B#4 and L5#3 to S1A#4.
- ( ) Fig. 5. Similarly position coil L6 (stock# 36007) on the S1B#5 and S1A#5 terminals of S1. Solder L6#1 to S1B#5 and L6#2 to S1A#5.
- ( ) Fig. 5. Connect S1B#6 and S1A#6 with a straight piece of heavy bus bar, soldering at both terminals. Trim off any excess. At the high frequency range of band F, this piece of wire acts as an inductance and is therefore designated as L7.
- ( ) Fig. 5. Connect and solder a short length of bare wire from S1B#9 to S1A#9.
- ( ) Fig. 5. Connect and solder one end of a length of bare wire to the mid-point of the bus bar designated as L7. In turn connect this wire to L6#2 (S), L5#2 (S), L4#2 (S), L3#2 (S), and L2#2 (C).
- ( ) Fig. 5. Connect one lead of the 4.7K $\Omega$  resistor R16 to L2#2 (S).

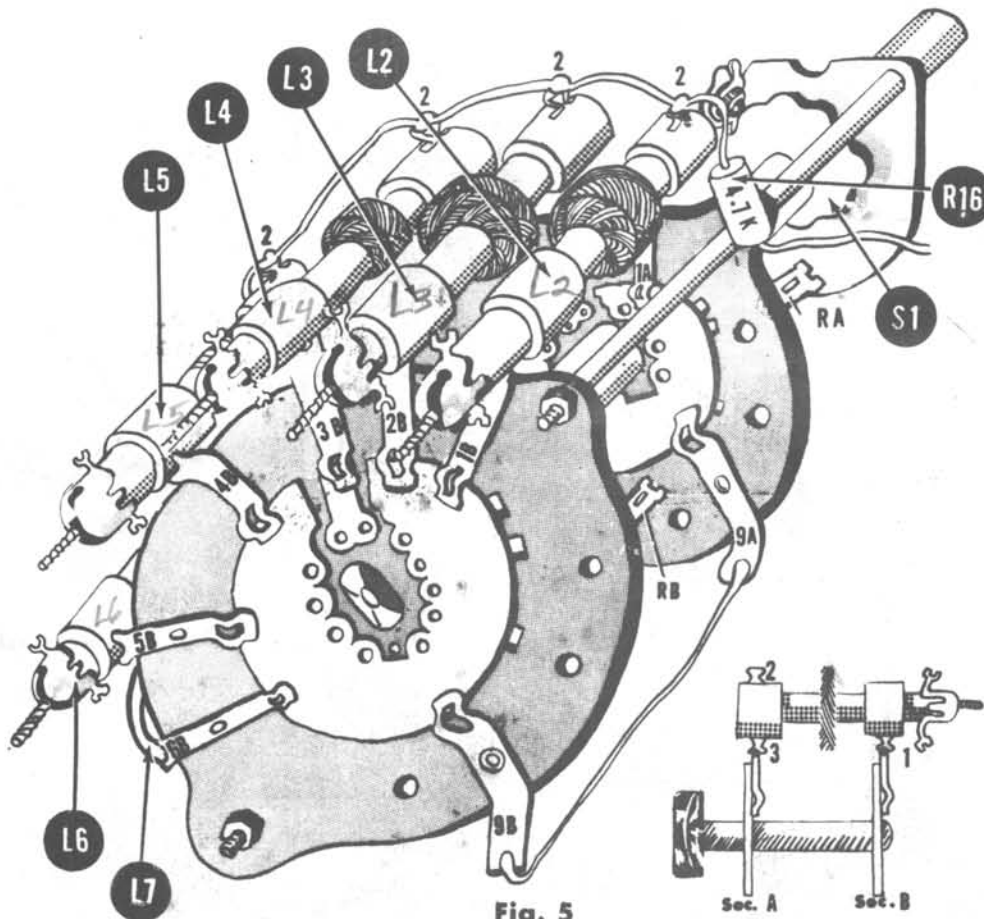
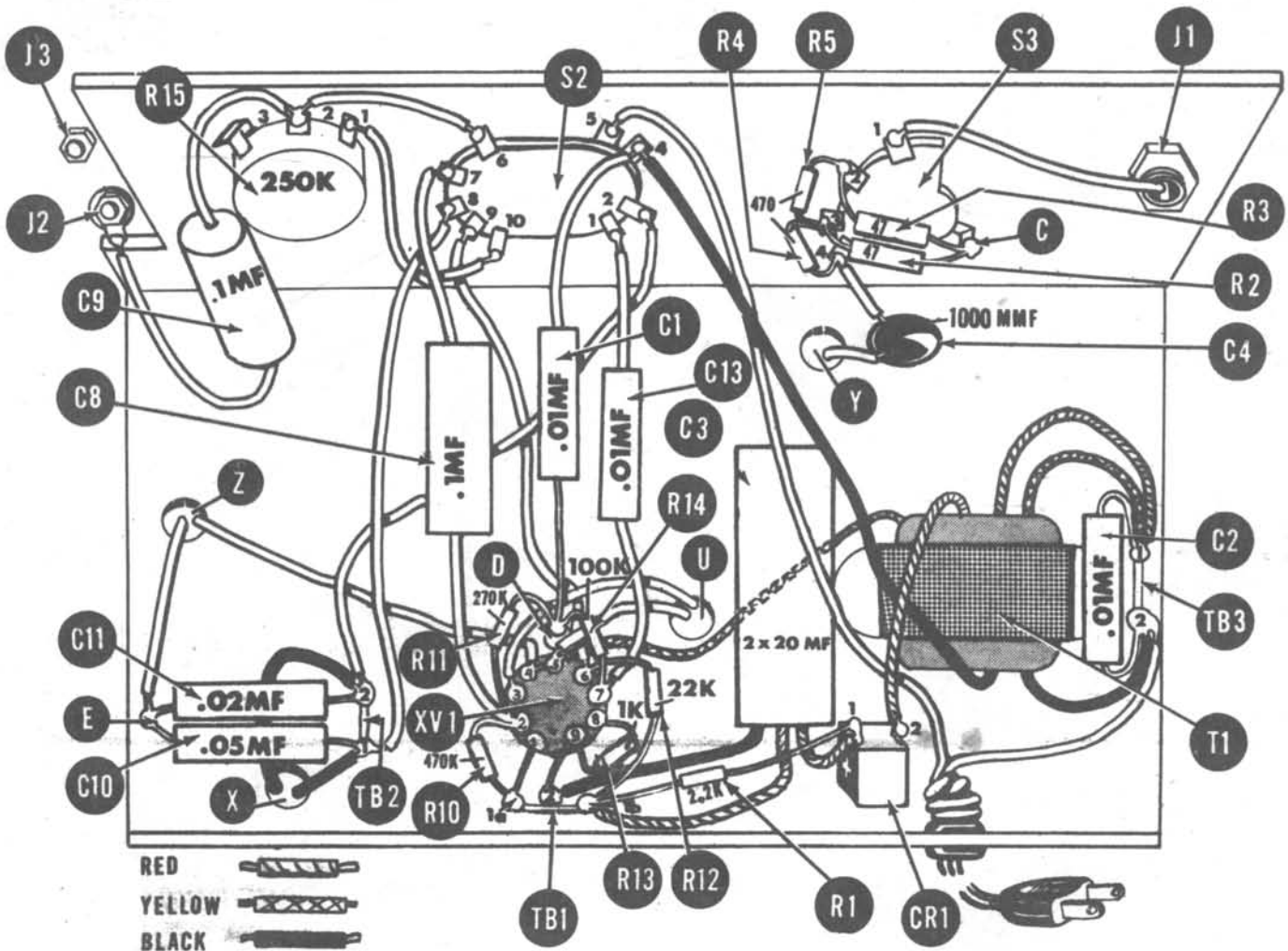

Fig. 5

## CHASSIS WIRING

- ( ) Fig. 6. Connect a length of hook-up wire from amphenol connector J1 (S) to switch terminal S3-1 (S). (To connect to the inner conductor terminal of amphenol connector J1, pass the wire through the connector and solder to the metal ring in the center of the plastic disc, using a minimum of solder. Trim off any excess lead protruding from the solder connection.)
- ( ) Fig. 6. Connect a 47Ω resistor R3 from S3-2 (C) to ground lug C (C). (Ground lug C is the ground lug mounted with S3.)
- ( ) Fig. 6. Connect a 470Ω resistor R5 from S3-2 (S) to S3-3 (C).
- ( ) Fig. 6. Connect a 47Ω resistor R2 from S3-3 (C) to ground lug C (S).
- ( ) Fig. 6. Connect a 470Ω resistor R4 from S3-3 (S) to S3-4 (C).
- ( ) Fig. 6. Connect a 1000 mmf capacitor C4 to S3-4 (S). The other lead is passed thru hole "Y". Use spaghetti on both leads.
- ( ) Fig. 6. Connect one yellow lead of power transformer T1 to XV1-5 (C).
- ( ) Fig. 6. Connect the other yellow lead of power transformer T1 to TB3-1 (C).
- ( ) Fig. 6. Connect one red lead of power transformer T1 to TB3-1 (C).





- ( ) Fig. 6. Connect a .01 mf capacitor C2 from TB3-1 (S) to TB3-2 (C).
- ( ) Fig. 6. Connect the other red lead of power transformer T1 to the negative terminal of the selenium rectifier CR-2 (S).
- ( ) Fig. 6. Connect one black lead of power transformer T1 to TB3-2 (C).
- ( ) Fig. 6. Connect the other black lead of power transformer T1 to switch terminal S2-4 (C).
- ( ) Fig. 6. Connect one red lead of the dual 20 mfd capacitor C3 to the positive terminal of the selenium rectifier CR1-1 (C).
- ( ) Fig. 6. Connect the 2.2K $\Omega$  resistor R1 from CR1-1 (S) to TB1-1B (C). Note that terminal strip TB1 has one insulated double lug. For reference purposes, the end of the double lug nearest selenium rectifier CR1 is designated as TB1-1B and the opposite end is designated as TB1-1A. The metal foot by which TB1 is mounted is designated as TB1-2.
- ( ) Fig. 6. Connect the other red lead of capacitor C3 to TB1-1B (C).
- ( ) Fig. 6. Connect the black lead of capacitor C3 to TB1-2 (C). Lug TB1-2 is the metal foot by which TB1 terminal is mounted.
- ( ) Fig. 6. Connect one end of a 6 in. piece of hook-up wire to XV1-3 (S). Pass the other end thru chassis hole "U".
- ( ) Fig. 6. Connect one end of a 6 in. piece of hook-up wire to XV1-5 (C). Pass the other end thru chassis hole "U".
- ( ) Fig. 6. Connect a short piece of bare wire from XV1-5 (S) to XV1-4 (C).
- ( ) Fig. 6. Connect one end of a 6 in. piece of hook-up wire to XV1-4 (S). Pass the other end thru chassis hole "Z".
- ( ) Fig. 6. Connect the 100K $\Omega$  resistor R14 from XV1-7 (C) to ground lug D (C).
- ( ) Fig. 6. Connect the .01 mf capacitor C13 from XV1-7 (S) to S2-1 (S). Use spaghetti on both leads.
- ( ) Fig. 6. Connect the 1K $\Omega$  resistor R13 from XV1-8 (S) to XV1-9 (C).
- ( ) Fig. 6. Connect a short length of bare wire from XV1-9 (S) to TB1-2 (S) (ground).
- ( ) Fig. 6. Connect a length of hook-up wire from XV1-6 (C) to S2-9 (S).
- ( ) Fig. 6. Connect the 22K $\Omega$  resistor R12 from XV1-6 (S) to TB1-1B (S).
- ( ) Fig. 6. Connect a .01 mf capacitor C1 from S2-4 (S) to ground lug D (C). Use spaghetti.
- ( ) Fig. 6. Connect the 270K $\Omega$  resistor R11 from ground lug D (S) to XV1-2 (C).
- ( ) Fig. 6. Connect a .1 mf capacitor C8 from XV1-2 (C) to S2-7 (S). Use spaghetti.
- ( ) Fig. 6. Connect the 470K $\Omega$  resistor R10 from XV1-2 (S) to TB1-1A (C).
- ( ) Fig. 6. Connect a short length of bare wire from XV1-1 (S) to TB1-1A (S).
- ( ) Fig. 6. Connect one of the black leads of a.f. resonant choke L1 (emerging from chassis hole "X") to TB2-1 (C).
- ( ) Fig. 6. Connect other black lead of choke L1 to TB2-2 (C).
- ( ) Fig. 6. Connect the .05 mf capacitor C10 from TB2-1 (C) to ground lug E (C).
- ( ) Fig. 6. Connect a length of hook-up wire from TB2-1 (S) to S2-8 (S).
- ( ) Fig. 6. Connect the .02 mf capacitor C11 from TB2-2 (C) to ground lug E (C).
- ( ) Fig. 6. Connect a length of hook-up wire from TB2-2 (S) to S2-2 (S).

- ( ) Fig. 6. Connect one end of a 3 in. length of hook-up wire to ground lug E (S) and pass the other end thru chassis hole "Z".
- ( ) Fig. 6. Connect a length of hook-up wire from S2-10 (S) to potentiometer R15-1 (S).
- ( ) Fig. 6. Connect a length of hook-up wire from S2-6 (S) to R15-2 (C).
- ( ) Fig. 6. Connect the .1 mf capacitor C9 from R15-2 (S) to binding post J2 (S). Use spaghetti.
- ( ) Fig. 6. Solder the ground lug mounted behind potentiometer R15 to terminal #3 of R15.
- ( ) Fig. 6. Pass the stripped end of the line cord through the grommet previously installed in the rear chassis apron and knot it 6 in. from the stripped ends. Connect one lead of the line cord to TB3-2 (S) and the other lead to S2-5 (S).

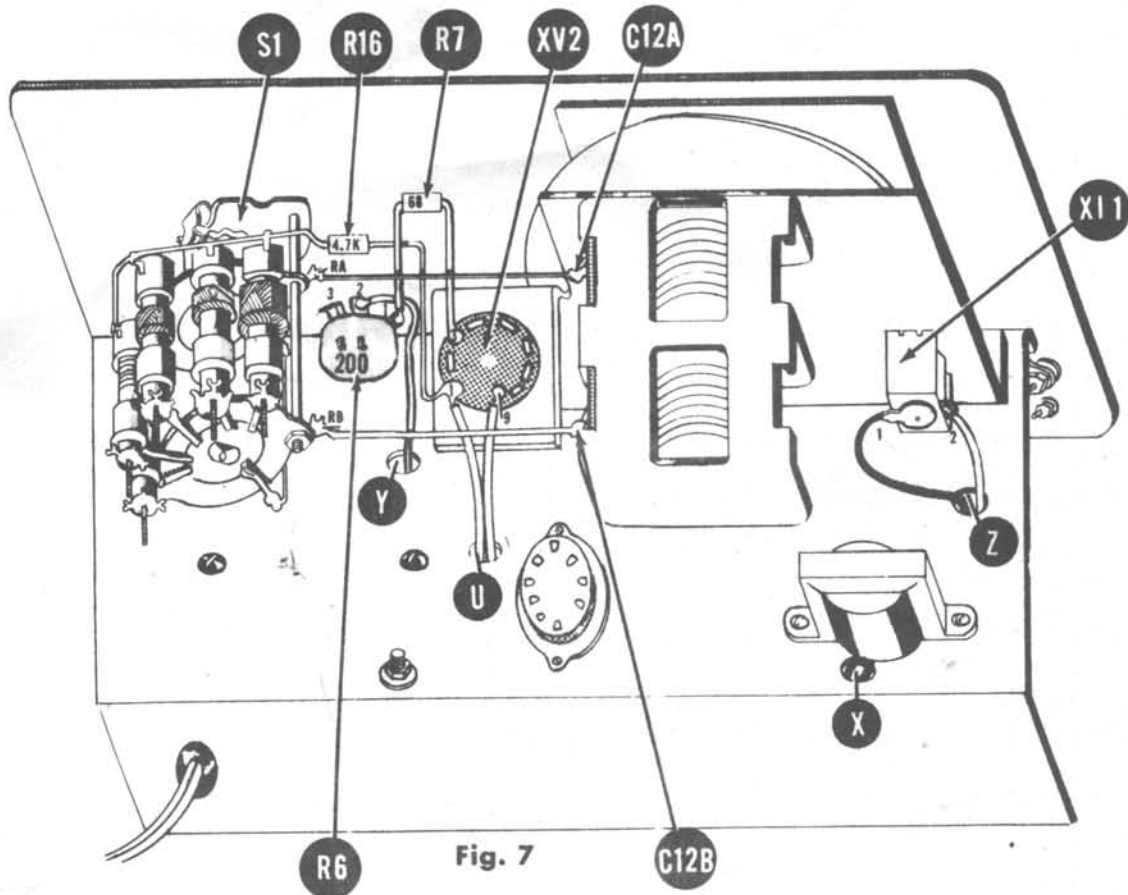

- ( ) Fig. 7. Mount the scale dial on the outer shaft of the tuning capacitor. (The dial will be adjusted to the proper position when the unit is calibrated.)
- ( ) Fig. 7. Mount the prewired sub-chassis to the main chassis using 2 #6-32 X 1/4 screws, 2 #6 hex nuts, and 2 #6 lock-washers.
- ( ) Fig. 7. Connect the 68Ω resistor R7 from XV2-3 (S) to RF FINE pot. R6-1 (S). Use spaghetti.
- ( ) Fig. 7. Connect the other end of the 1000 mmf capacitor C4 emerging from hole "Y" to R6-2 (S). Use spaghetti.
- ( ) Fig. 7. Solder the ground lug mounted behind potentiometer R6 to R6-3 (S).
- ( ) Fig. 7. Mount the prewired Band Sel switch S1 to the panel. Use 2-3/8 hex nuts, 1-3/8 lock washers and 1-3/8 flat washer. Switch S1 is shown in approximately the correct position in the drawing. Before tightening the outside hex nut, use a pair of pliers to turn the shaft to the farthest counter-clockwise position and then orient the switch so that the flat on the shaft faces away from the A band position.

- ( ) Fig. 7. Connect the lead coming from XV1-5 and emerging from hole "U" to XV2-9 (S).
- ( ) Fig. 7. Connect the lead coming from XV1-3 and emerging from hole "U" to XV2-1 (C).
- ( ) Fig. 7. Connect the free lead of the 4.7K $\Omega$  resistor R16 coming off L2#2 to XV2-1 (S).
- ( ) Fig. 7. Connect a straight length of heavy bus bar from S1-RA (S) to C12A (S).
- ( ) Fig. 7. Connect a straight length of heavy bus bar from S1-RB (S) to C12B (S).
- ( ) Fig. 7. Insert the #47 pilot lamp I1 in the holder X11 and slip the 5/8" length of tubing over the bulb. Compress the holder and insert the bulb in the sub-chassis hole so that the exposed bulb tip enters the hole in the plexiglass.
- ( ) Fig. 7. Connect the lead coming from XV1-4 and emerging from hole "Z" to X11-2 (S).
- ( ) Fig. 7. Connect the lead coming from ground lug E and emerging from hole "Z" to X11-1 (S).

### PREPARATION OF RF OUTPUT CABLE

- ( ) Figs. 8 & 9 Connect the female co-axial connector to one end of the length of co-axial cable provided as follows: Strip the cable end exactly as shown in Fig. 8. Disassemble the connector. As shown in Fig. 9, slip the stripped cable end into the larger diameter end of the spring and then solder the small diameter end of the spring to the very edge of the metal braid. Slip the connector ring over the cable end past the spring, unthreaded end first. Pass the cable end thru the tapered end of the connector (threading the inner conductor thru the eyelet in the bakelite disc) until passage is stopped by the larger spring diameter. Tighten the set screw in the connector body so that the cable and spring will be secured mechanically. Solder the inner conductor of the cable to the eyelet in the bakelite disc and trim off excess lead. A section of the internally threaded part of the connector ring should extend past the connector body to enable coupling to the male connector on the panel. Complete the opposite end of the cable as follows: Strip away 3 1/2" of outer insulation and 3" of the outer braid. Cut off 4" of stranded wire and strip off 1/2" of insulation from one end. Wrap the stripped end around the exposed cable braid and solder, being careful not to overheat the cable. Finally connect and solder a crocodile clip to the opposite end of this lead and to the inner conductor of the co-axial cable.

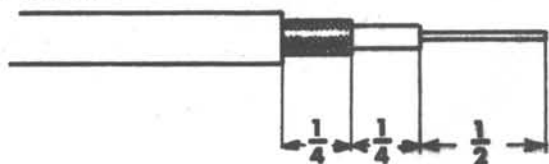

Fig. 8



Fig. 9

### FINAL STEPS

You have now completed the assembly and wiring of your instrument. When you have completed the following steps, your instrument will be ready for use.

- 1) Make a careful examination of the unit to determine whether all joints are soldered properly. Check for loose lumps of solder and straighten out the wiring and components so that there are no accidental shorts.
- 2) The flowing of rosin between switch contacts causes leakage. If examination reveals the presence of rosin, remove it by briskly cleaning the area between the contacts with a stiff brush saturated with carbon tetrachloride. Be very careful not to spring the contacts when cleaning switches.
- 3) Insert the 12AU7 tube V1 into tube socket XV1 on the chassis.
- 4) Insert the 12AV7 tube V2 into tube socket XV2 on the sub-assembly bracket.
- 5) Mount the tuning knob (scalloped rim) on the shaft of the tuning capacitor and tighten the set screw.
- 6) Turn the shafts of the RF FINE and AF MOD/OUTPUT controls maximum counter-clockwise. Mount a knob on each shaft and tighten the set screw with the knob pointing at zero (0) on the dial in both cases.

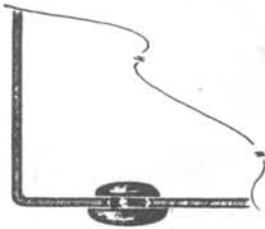

Fig. 10

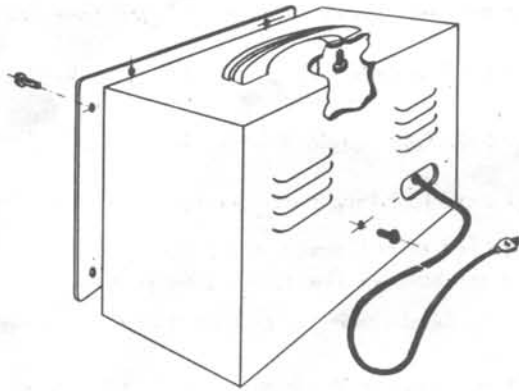

Fig. 11

7) Place knobs on the RF COARSE, BAND SEL., and SIGNAL SEL. switches. In each case, tighten the set screw against the flat on each switch shaft. If the assembly instructions given previously were followed correctly, each knob should then point at the furthest counter-clockwise position on each dial.

8) Before connecting the instrument to the a-c line, connect an ohmmeter from B plus (positive terminal CR1) to ground (chassis). The resistance should not be less than 200,000 ohms. (NOTE: wait until the ohmmeter reading reaches the final value.). If the resistance is under 200,000 ohms, do not connect to the a-c line before you have checked the rectifier circuit and remedied the trouble.

9) Position the tuning dial and calibrate the instrument as described in the Instruction Book.

10) Insert the rubber feet in the openings provided in the bottom of the cabinet as shown. The method is to work the rounded portion of each foot into the interior of the cabinet from the outside, using a small screwdriver. The flat portion should be the actual resting or contact surface. See insert drawing of Fig. 10.

11) Mount the handle on the cabinet with two #10-24 screws as shown in Fig. 11.

12) Run the a-c line cord through the rear cabinet opening and insert the completed unit in the cabinet. Align the hole in the cabinet rear and the hole in the rear chassis apron and insert 1 #6 P.K. screw. Then align the 8 panel holes with the corresponding holes in the cabinet flange and insert 8 #6 P.K. screws. Tighten all screws. See Fig. 11.

#### NOTE

If the instrument fails to operate properly, recheck the wiring for errors or reversed connections, test for continuity, and check individual components for breakdown. Check all dc and ac operating voltages, keeping in mind that all voltages may vary from the values shown by as much as 15% due to component tolerance, line voltage variations, and type of measuring instrument used (schematic voltages were measured with VTVM).

#### SERVICE

If you are still having difficulty, write to our service department listing all possible indications that might be helpful. If desired, you may return the instrument to our factory where it will be placed in operating condition for \$5.00 plus the cost of parts replaced due to their being damaged in the course of construction. This service policy applies only to completed instruments constructed in accordance with the instructions as stated in the manual. Instruments that are not completed or instruments that are modified will not be accepted for repair. Instruments that show evidence of acid core solder or paste fluxes will be returned not repaired. **NOTE:** Before returning this unit, be sure all parts are securely mounted. Attach a tag to the instrument, giving your home address and the trouble with the unit. Pack very carefully in a rugged container, using sufficient packing material (cotton, shredded newspaper, or excelsior), to make the unit completely immovable within the container. The original shipping carton is satisfactory, providing the original inserts are used or sufficient packing material is inserted to keep the instrument immovable. Ship by prepaid Railway Express, if possible, to the Electronic Instrument Co., Inc. 33-00 Northern Blvd., Long Island City 1, New York. Return shipment will be made by express collect. Note that a carrier cannot be held liable for damages in transit if packing, IN HIS OPINION, is insufficient.

# RESISTOR COLOR CODES

RMA COLOR CODE FOR FIXED COMPOSITION RESISTORS

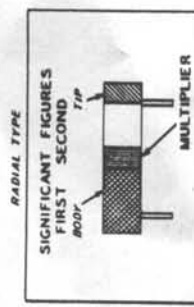
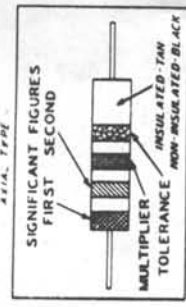

JAN COLOR CODE FOR FIXED COMPOSITION RESISTORS

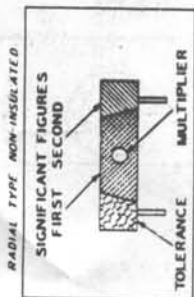
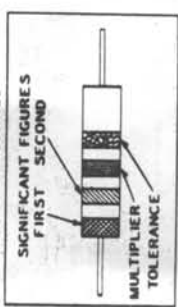

# CAPACITOR COLOR CODES

RMA 3-DOT COLOR CODE FOR MICA-DIELECTRIC CAPACITORS

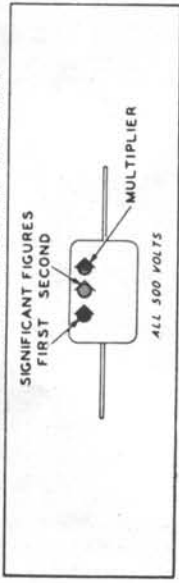

JAN 6-DOT COLOR CODE FOR PAPER-DIELECTRIC CAPACITORS

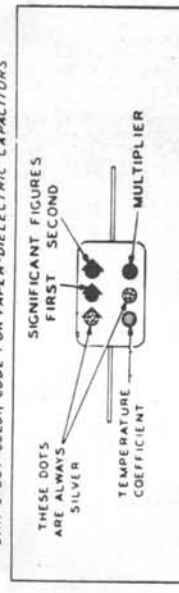

RMA 6-DOT COLOR CODE FOR MICA-DIELECTRIC CAPACITORS

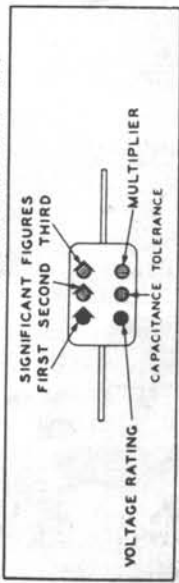

JAN 6-DOT COLOR CODE FOR MICA-DIELECTRIC CAPACITORS

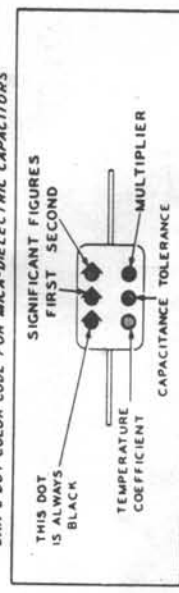

RMA COLOR CODE FOR TUBULAR CERAMIC-DIELECTRIC CAPACITORS

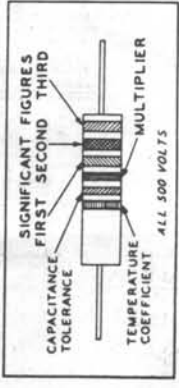

JAN COLOR CODE FOR FIXED CERAMIC-DIELECTRIC CAPACITORS

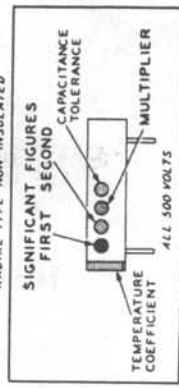

AXIAL TYPE INSULATED

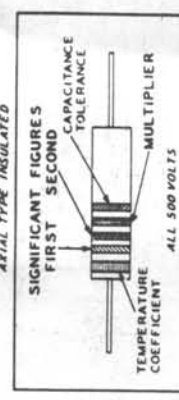

RMA: RADIO MANUFACTURERS ASSOCIATION  
JAN: JOINT ARMY-NAVY

| RESISTORS |            | CAPACITORS         |          |                                 |                               |                        |                |                         |
|-----------|------------|--------------------|----------|---------------------------------|-------------------------------|------------------------|----------------|-------------------------|
| TOLERANCE | MULTIPLIER | SIGNIFICANT FIGURE | COLOR    | RMA MICA AND CERAMIC-DIELECTRIC | JAN MICA AND PAPER-DIELECTRIC | JAN CERAMIC DIELECTRIC | VOLTAGE RATING | TEMPERATURE COEFFICIENT |
| 5         | 0.1        | 0                  | BLACK    | 1                               | 1                             | 1                      | 100            | A                       |
| 10        | 0.01       | 1                  | BROWN    | 10                              | 10                            | 10                     | 100            | B                       |
| 20        |            | 2                  | RED      | 100                             | 100                           | 100                    | 200            | C                       |
|           |            | 3                  | ORANGE   | 1000                            | 1000                          | 1000                   | 300            | D                       |
|           |            | 4                  | YELLOW   | 10000                           | 10000                         |                        | 400            | E                       |
|           |            | 5                  | GREEN    | 100000                          | 100000                        |                        | 500            | F                       |
|           |            | 6                  | BLUE     | 1000000                         | 1000000                       |                        | 600            | G                       |
|           |            | 7                  | VIOLET   | 10000000                        | 10000000                      | 0.01                   | 700            |                         |
|           |            | 8                  | GRAY     | 100000000                       | 100000000                     | 0.1                    | 800            |                         |
|           |            | 9                  | WHITE    | 1000000000                      | 1000000000                    | 0.01                   | 900            |                         |
|           |            |                    | GOLD     | 0.1                             | 0.1                           |                        | 1000           |                         |
|           |            |                    | SILVER   | 0.01                            | 0.01                          |                        | 2000           |                         |
|           |            |                    | NO COLOR |                                 |                               |                        | 500            |                         |



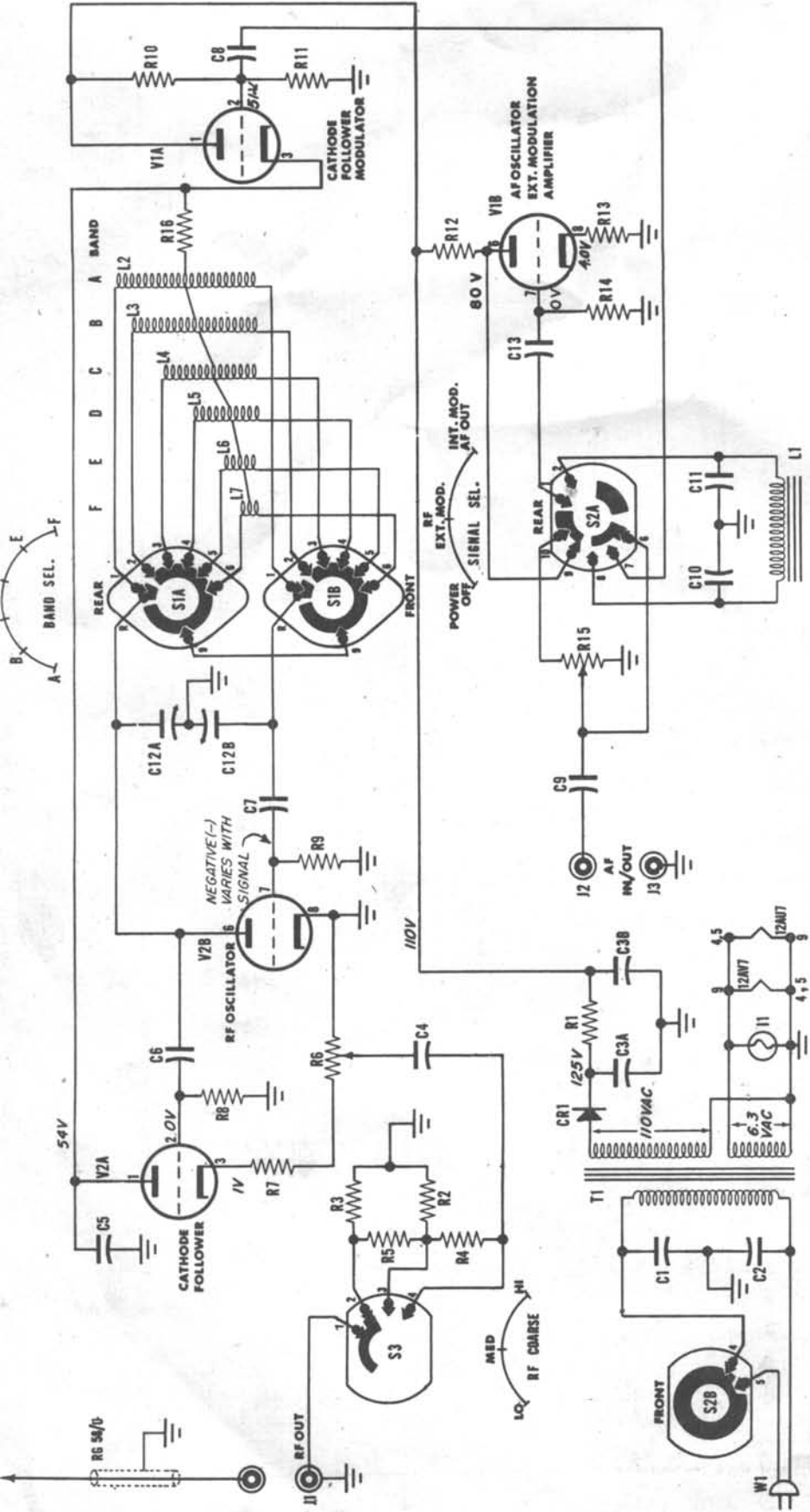

| STOCK # | SYM.    | DESCRIPTION                  | STOCK # | SYM. | DESCRIPTION                 |
|---------|---------|------------------------------|---------|------|-----------------------------|
| 20000   | C1,2,13 | cap., paper, .01 mf-400V     | 10028   | R10  | res., 470KΩ, 1/2 W, 20%     |
| 23009   | C3      | cap., elec., 2 X 20 mf-150 V | 10419   | R11  | res., 270KΩ, 1/2 W, 10%     |
| 22500   | C4,5    | cap., disc., 1000 mmf        | 10424   | R12  | res., 22KΩ, 1/2 W, 10%      |
| 22008   | C6      | cap., cer., 5 mmf            | 10432   | R13  | res., 1KΩ, 1/2 W, 10%       |
| 22007   | C7      | cap., cer., 47 mmf           | 10410   | R14  | res., 100KΩ, 1/2 W, 10%     |
| 20006   | C8,9    | cap., paper, .1 mf-400V      | 16002   | R15  | pot., 250KΩ                 |
| 20001   | C10     | cap., paper, .05 mf-400V     | 10012   | R16  | res., 4.7KΩ, 1/2 W, 20%     |
| 20008   | C11     | cap., paper, .02 mf-400V     | S1      |      | switch, BAND SEL., 6 pos.   |
| 29004   | C12     | cap., tuning                 | S2      |      | switch, SIGNAL SEL., 3 pos. |
| 93003   | CR1     | rect., 50 ma                 | S3      |      | switch, RF COARSE, 3 pos.   |
| 92000   | I1      | bulb, #47                    | T1      |      | transformer, power          |
| 50002   | J1      | amphenol, male               | V1      |      | 12AU7 tube                  |
| 52001   | J2,3    | binding post, 5 way          | V2      |      | 12AV7 tube                  |
| 34501   | L1      | choke                        |         |      |                             |

# MODEL 324 SIGNAL GENERATOR



# **K4XL's** **BAMA**

This manual is provided **FREE OF CHARGE** from the "BoatAnchor Manual Archive" as a service to the Boatanchor community.

It was uploaded by someone who wanted to help you repair and maintain your equipment.

If you paid anyone other than BAMA for this manual, you paid someone who is making a profit from the free labor of others without asking their permission.

You may pass on copies of this manual to anyone who needs it. But do it without charge.

Thousands of files are available without charge from BAMA. Visit us at <http://bama.sbc.edu>